

COMMENTS			
1	storage rack	9	single round sink
2	electric fryer, 2 tanks 2 baskets	10	single square sink
3	stainless steel range hood shell	11	Tracking light
4	electric griddle	12	
5	working bench fridge/freezer adjustable	13	
6	salad/pizza bench fridge	14	
7	Roof mounted AC unit	15	
8	Bench 1/2 fridge + 1/2 freezer	16	

	NAME	DATE	SIGN
DIRECTOR	GAD	2025/05/09	
DESIGNER	BIGGUO	2025/05/09	
REVIEWER	GAD	2025/05/09	

#1, #2
5.1x2.2m Airstream

xTITLE:

SIZE	SCALE	SOECIED TOLERANCES	MADE IN	SHEET
A3	1:1	±5		1 OF 5
FOOD TRUCK ELEVATION INDEX				
xDWG. NO.				

WIDTH	2200	[MM]
LENGTH	5100	[MM]
HEIGHT	2490	[MM]
xEXTERIOR DIMENSIONS		

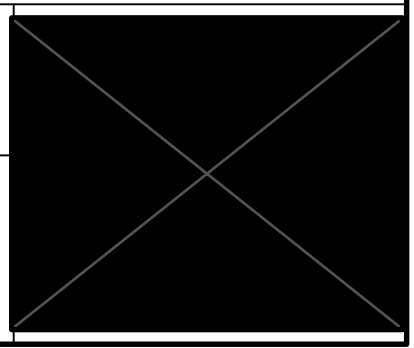
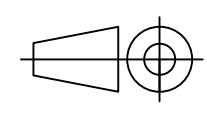

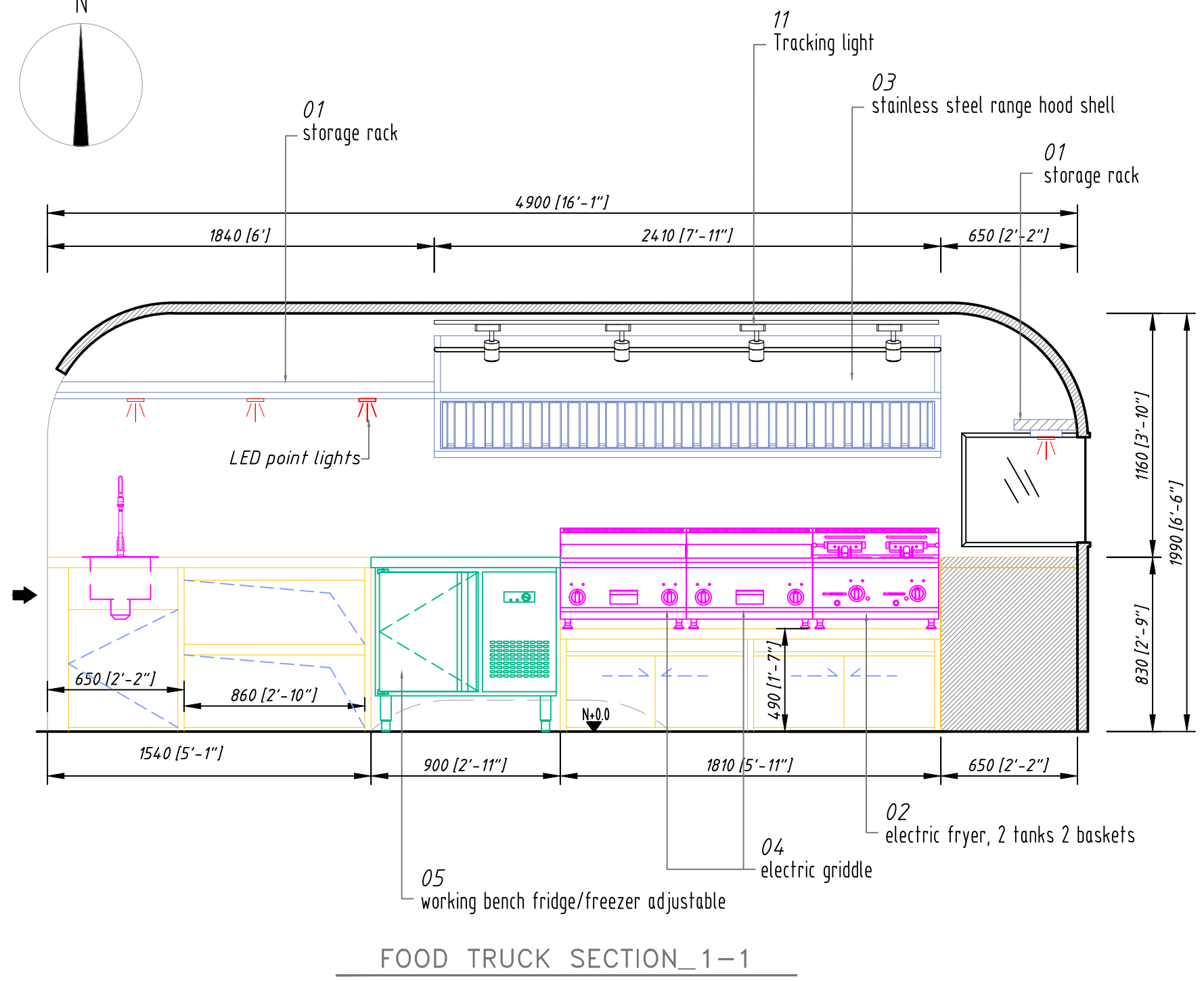
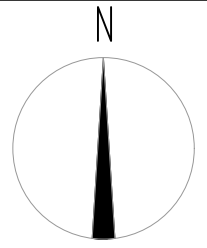

FOOD TRUCK SECTION_1-1

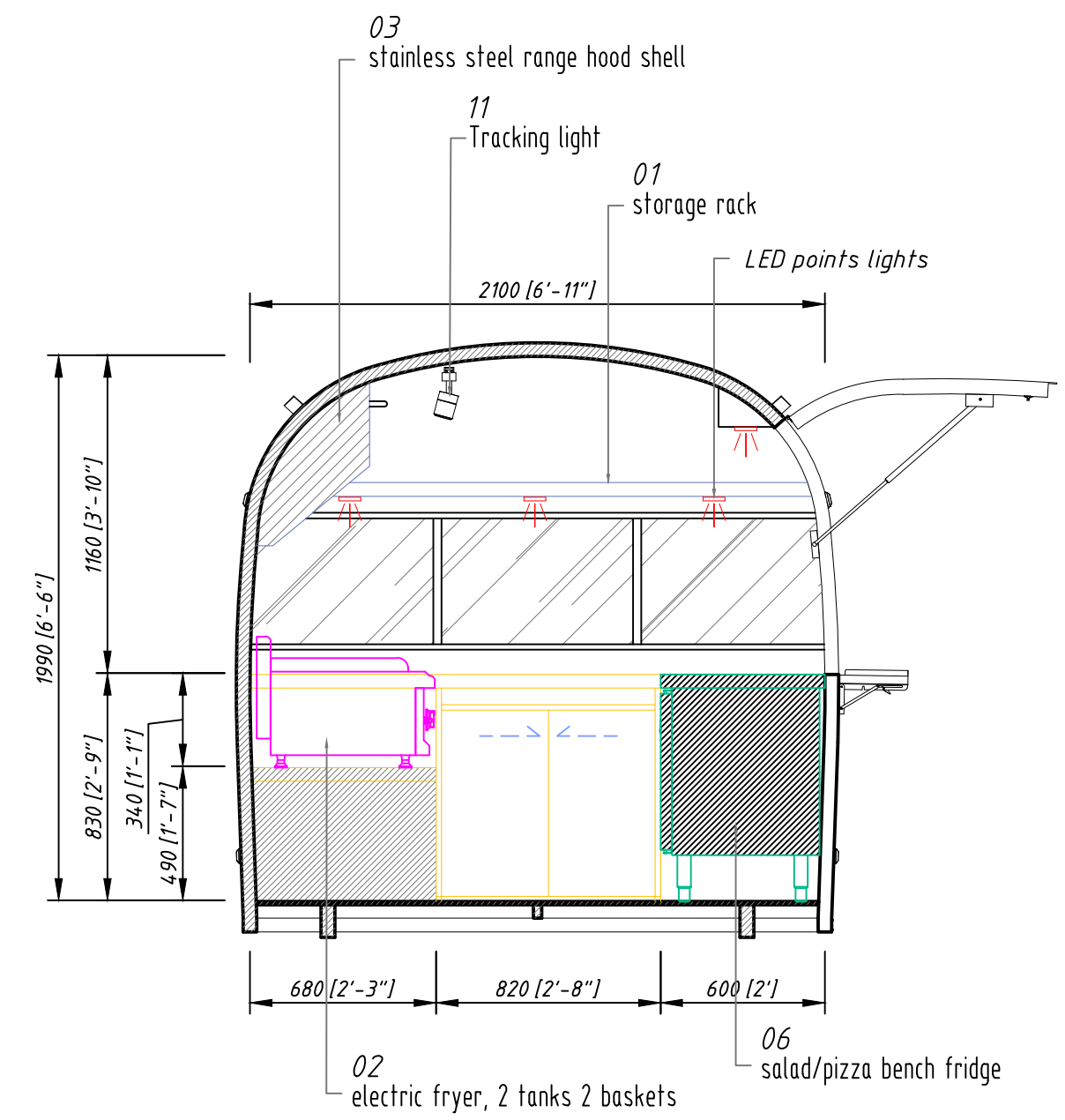

FOOD TRUCK SECTION_3-3

COMMENTS				NAME	DATE	SIGN	SIZE	SCALE	SOECIED TOLERANCES	MADE IN	SHEET					
1	storage rack	9	single round sink	DIRECTOR	GAD	2025/05/09	A3	1:1	±5		2 OF 5	WIDTH	2200 [MM]			
2	electric fryer, 2 tanks 2 baskets	10	single square sink	DESIGNER	BIGGUO	2025/05/09						LENGTH	5100 [MM]			
3	stainless steel range hood shell	11	Tracking light	REVIEWER	GAD	2025/05/09						HEIGHT	2490 [MM]			
4	electric griddle	12		#1, #2 5.1x2.2m Airstream			FOOD TRUCK SECTION		xEXTERIOR DIMENSIONS							
5	working bench fridge/freezer adjustable	13									xTITLE:		xDWG. NO.			
6	salad/pizza bench fridge	14														
7	Roof mounted AC unit	15														
8	Bench 1/2 fridge + 1/2 freezer	16														

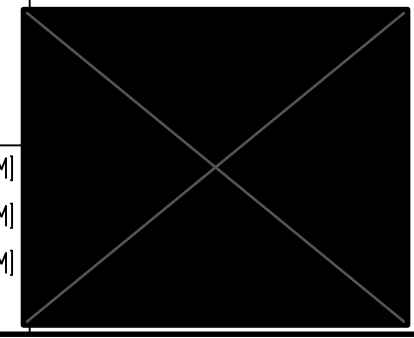
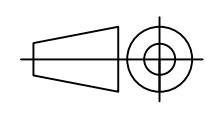

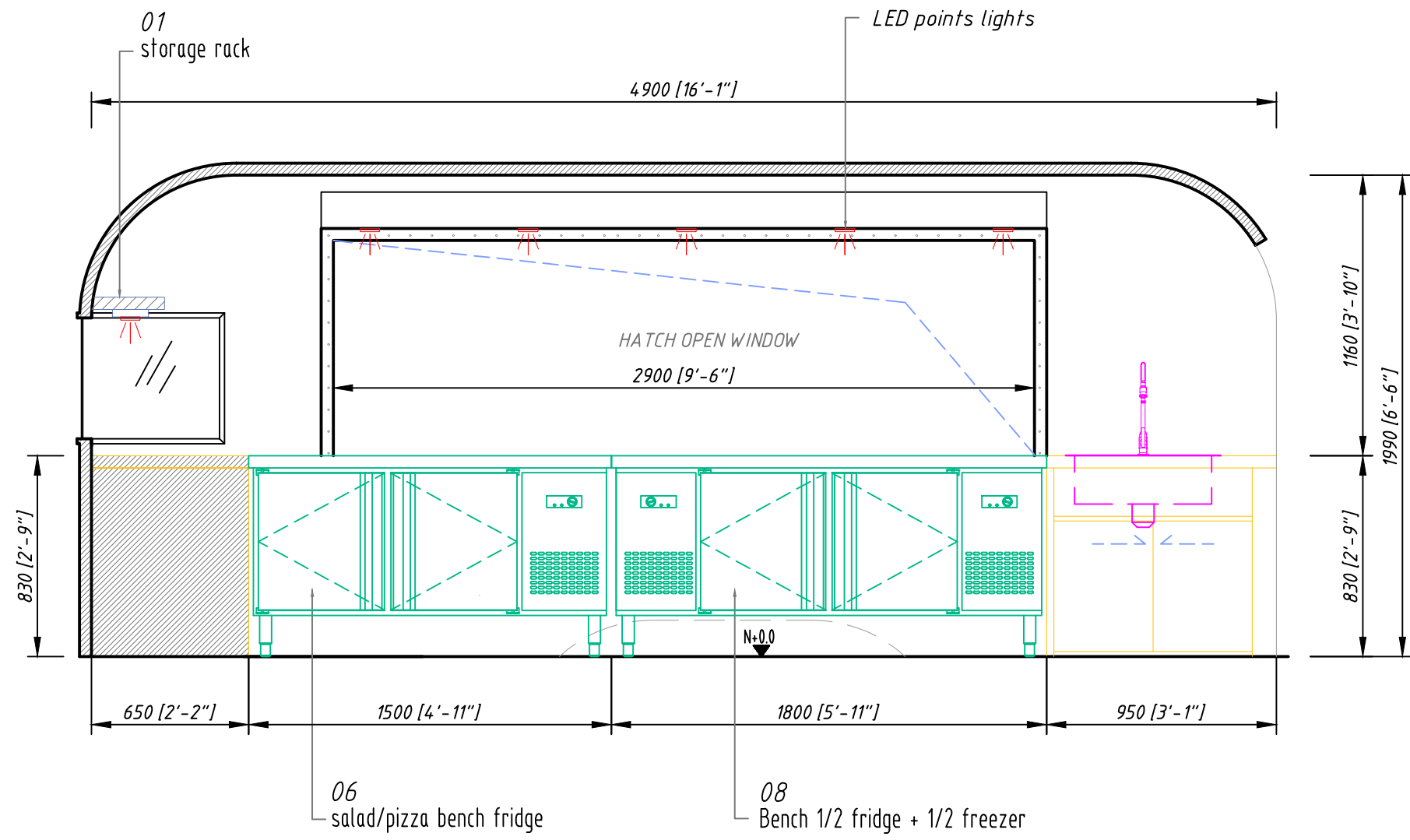
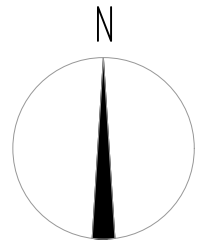

FOOD TRUCK SECTION_2-2

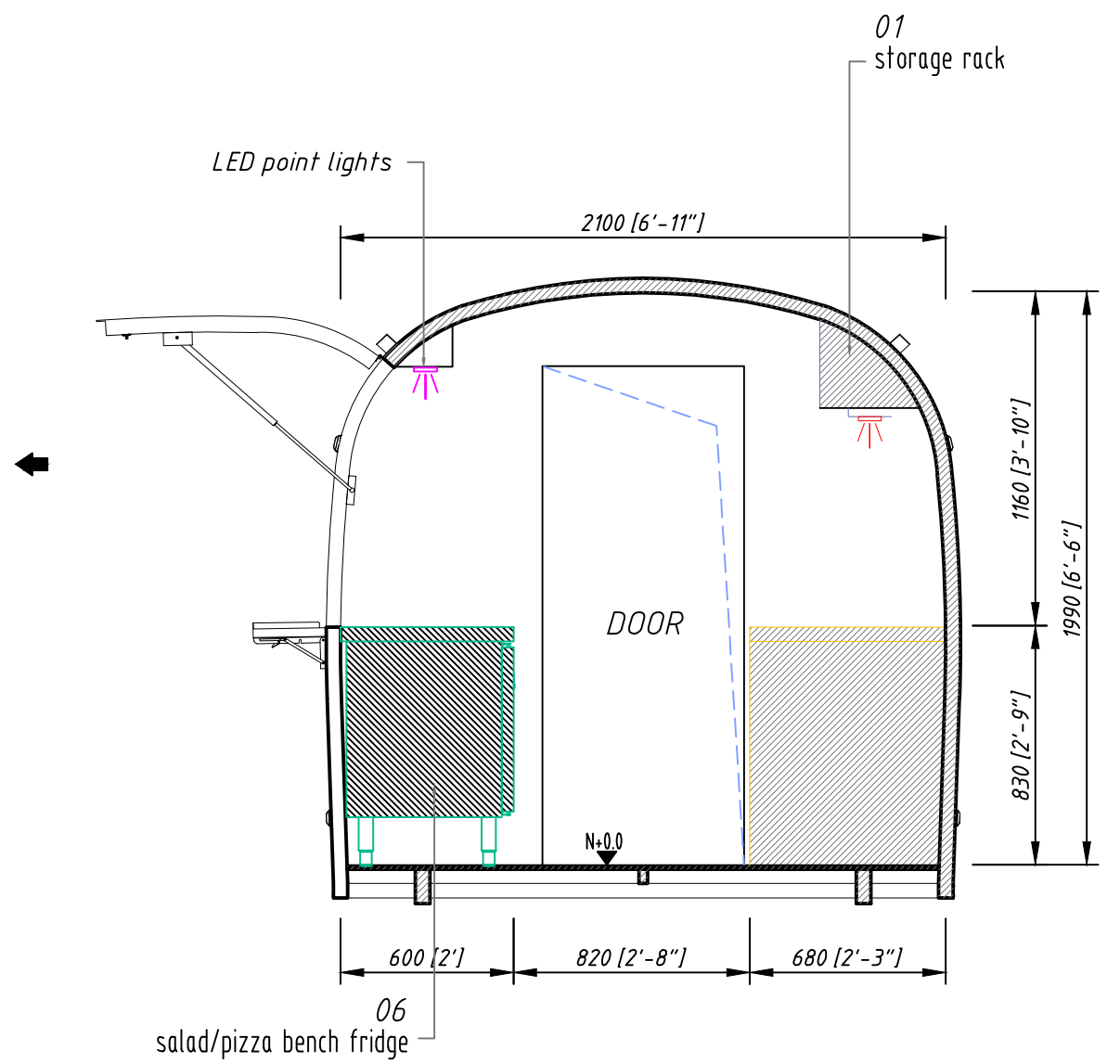

FOOD TRUCK SECTION_4-4

COMMENTS				NAME	DATE	SIGN	SIZE	SCALE	SOECIED TOLERANCES	MADE IN	SHEET		
1	storage rack	9	single round sink	DIRECTOR	GAD	2025/05/09	A3	1:1	±5		3 OF 5	WIDTH	2200 [MM]
2	electric fryer, 2 tanks 2 baskets	10	single square sink	DESIGNER	BIGGUO	2025/05/09						LENGTH	5100 [MM]
3	stainless steel range hood shell	11	Tracking light	REVIEWER	GAD	2025/05/09						HEIGHT	2490 [MM]
4	electric griddle	12		#1, #2 5.1x2.2m Airstream			FOOD TRUCK SECTION		xDWG. NO.		xEXTERIOR DIMENSIONS		
5	working bench fridge/freezer adjustable	13											
6	salad/pizza bench fridge	14											
7	Roof mounted AC unit	15											
8	Bench 1/2 fridge + 1/2 freezer	16		xTITLE:									

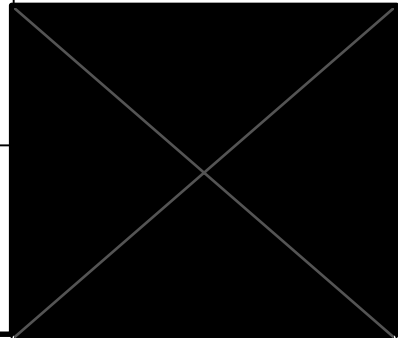
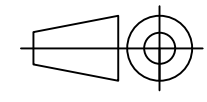

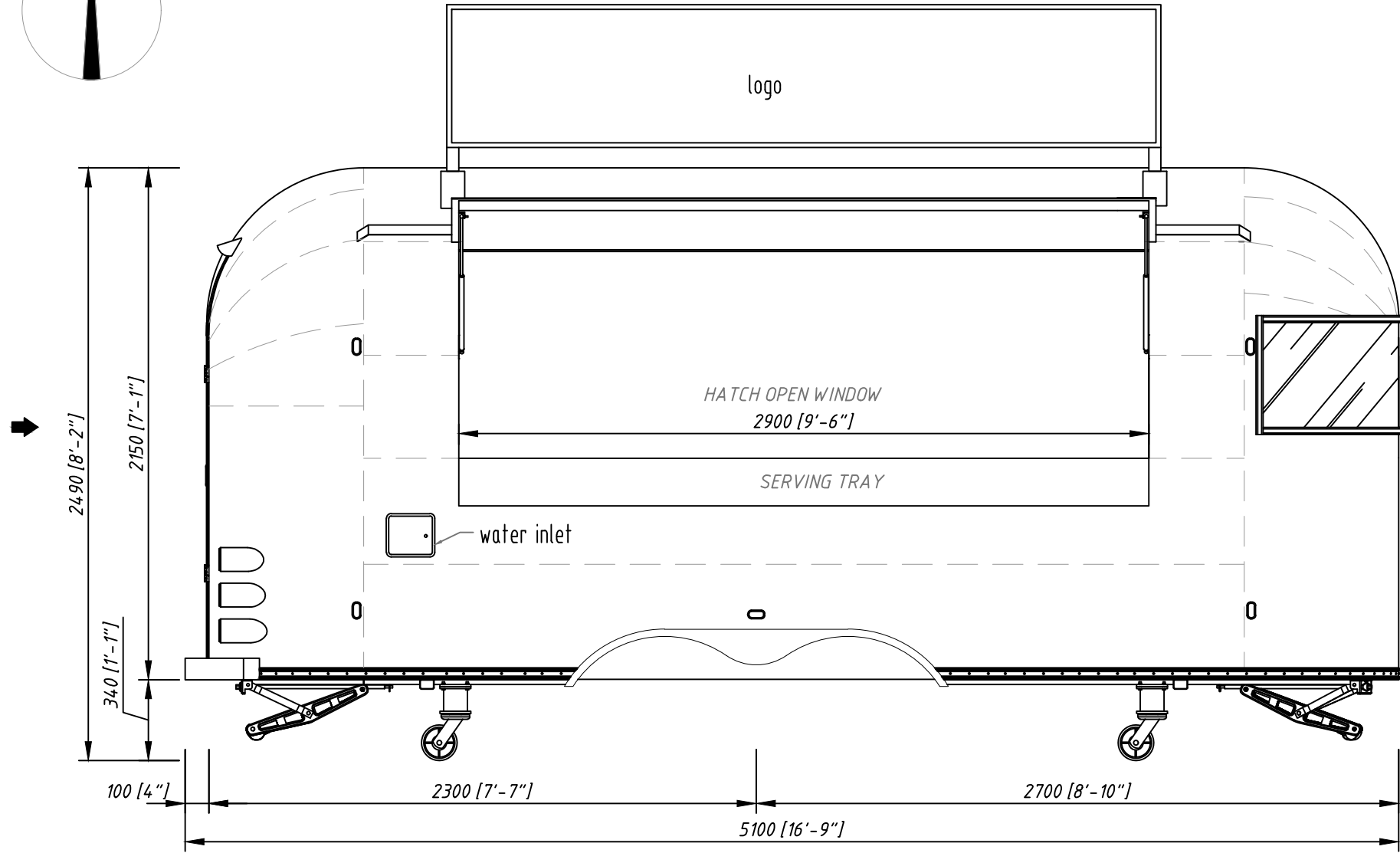
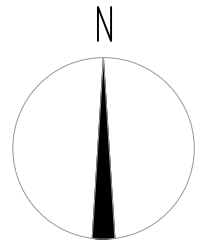

FOOD TRUCK CUSTOM SIDE ELEVATION_B

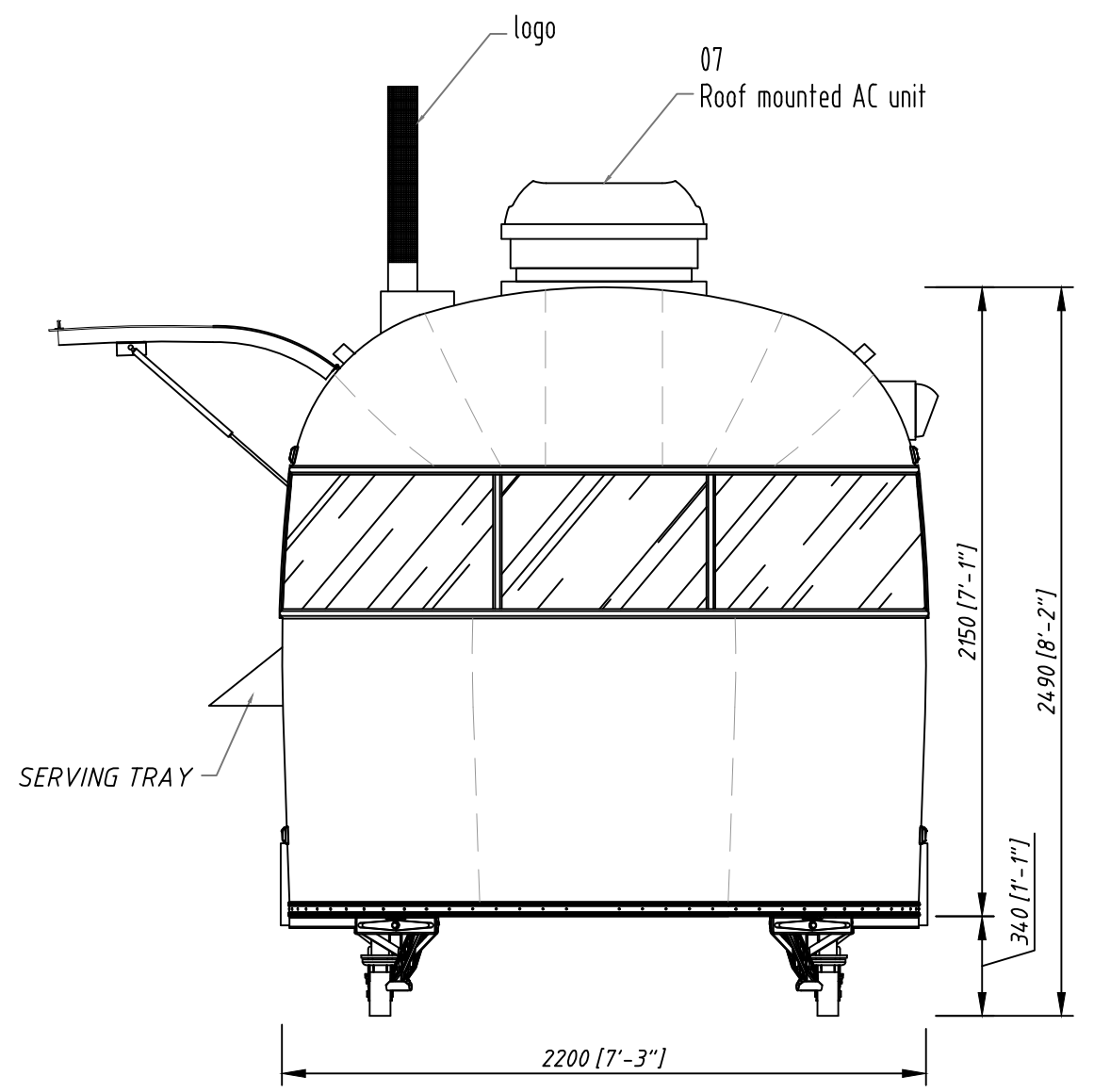

FOOD TRUCK CUSTOM SIDE ELEVATION_B

COMMENTS				NAME	DATE	SIGN	SIZE	SCALE	SOECIED TOLERANCES	MADE IN	SHEET		
1	storage rack	9	single round sink	DIRECTOR	GAD	2025/05/09	A3	1:1	±5		4 OF 5	WIDTH	2200 [MM]
2	electric fryer, 2 tanks 2 baskets	10	single square sink	DESIGNER	BIGGUO	2025/05/09						LENGTH	5100 [MM]
3	stainless steel range hood shell	11	Tracking light	REVIEWER	GAD	2025/05/09						HEIGHT	2490 [MM]
4	electric griddle	12		#1, #2 5.1x2.2m Airstream			FOOD TRUCK CUSTOM SIDE ELEVATION		xEXTERIOR DIMENSIONS				
5	working bench fridge/freezer adjustable	13											
6	salad/pizza bench fridge	14											
7	Roof mounted AC unit	15											
8	Bench 1/2 fridge + 1/2 freezer	16											
				xTITLE:			xDWG. NO.						

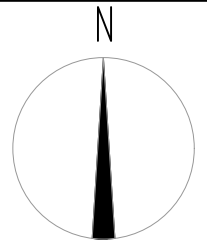
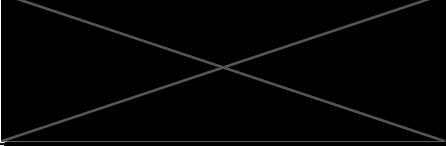

07 Roof mounted AC unit
07 Roof mounted AC unit

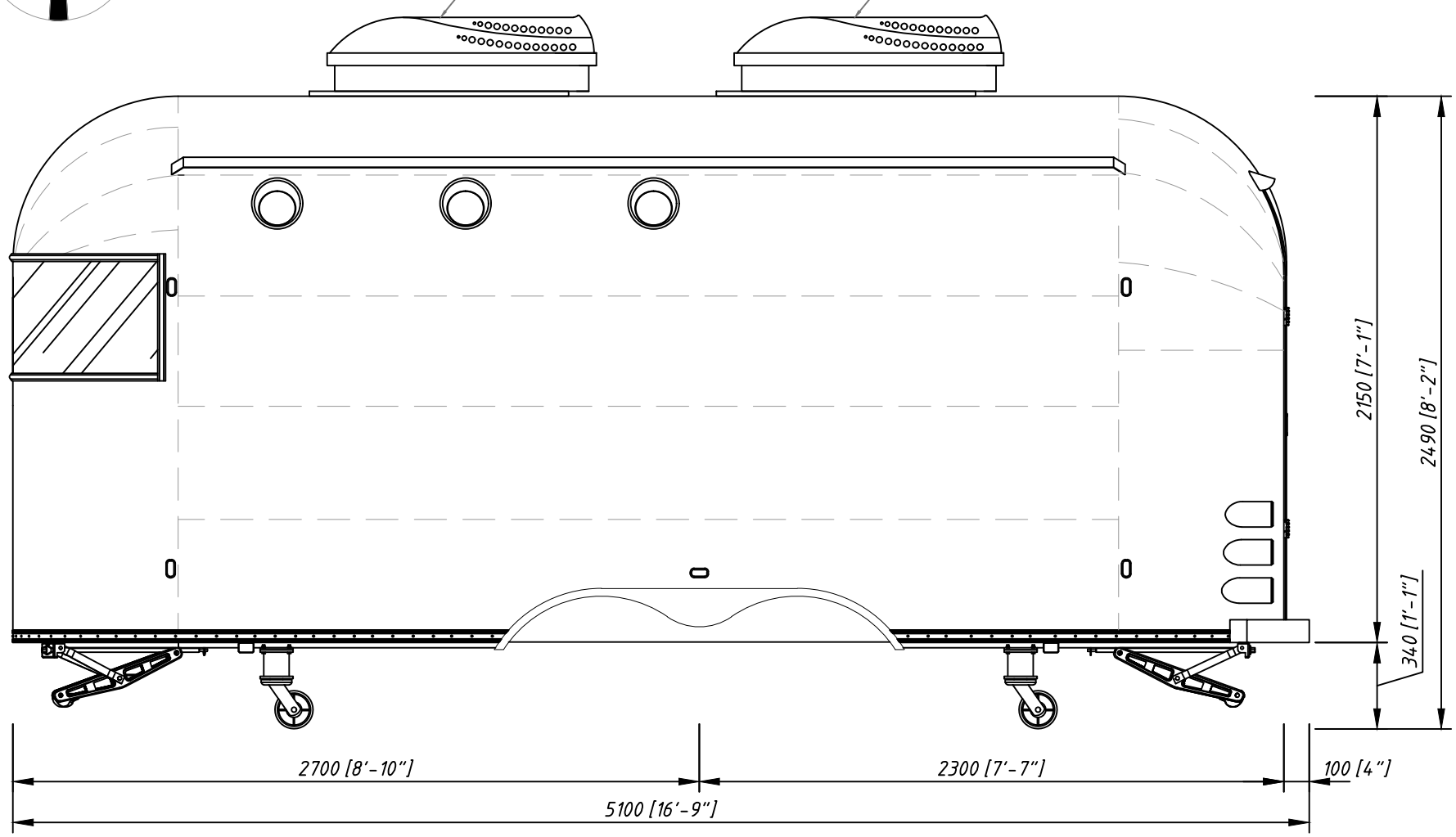

FOOD TRUCK CUSTOM SIDE ELEVATION_A

07 Roof mounted AC unit

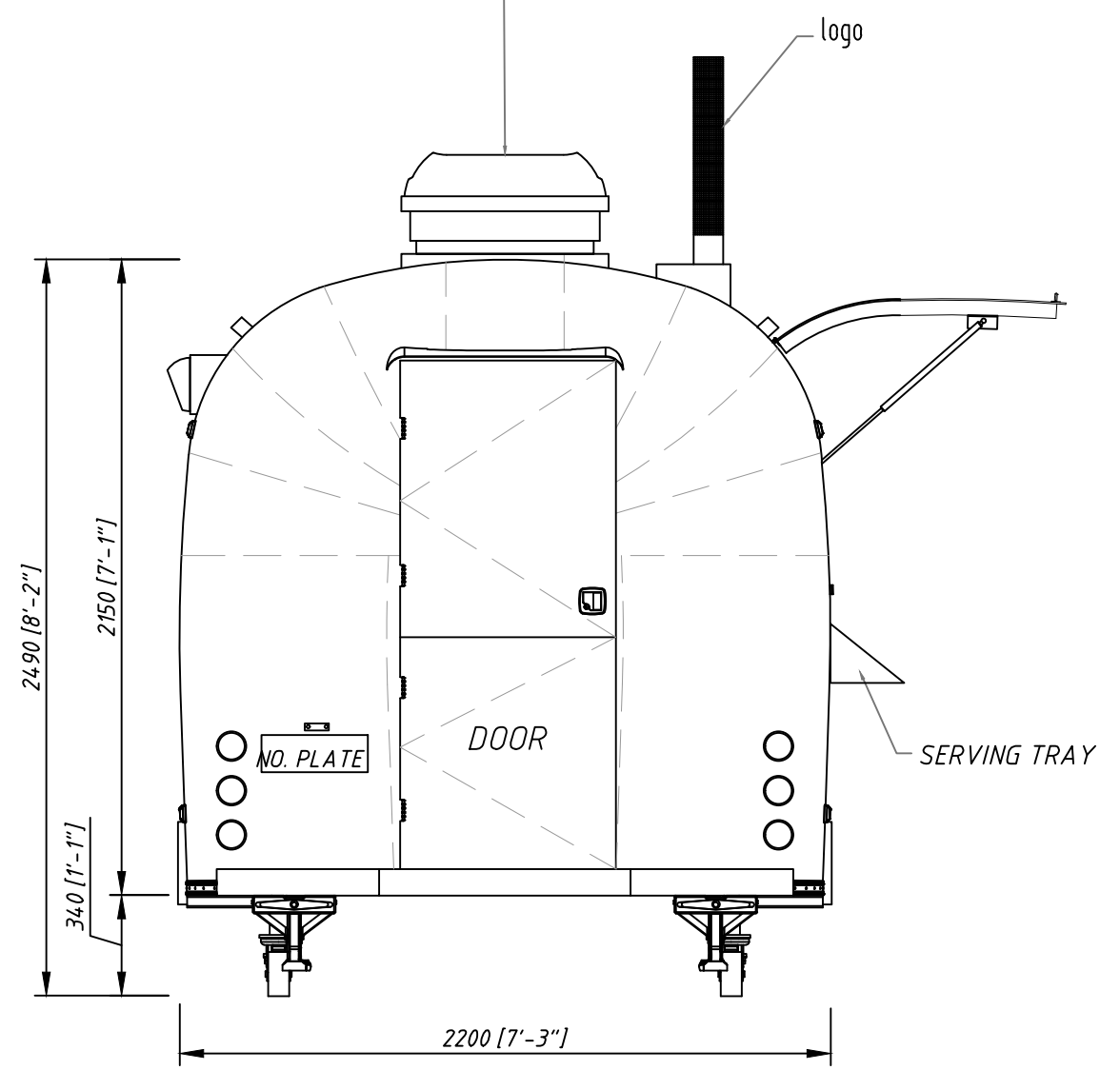

FOOD TRUCK CUSTOM SIDE ELEVATION_D

COMMENTS				NAME	DATE	SIGN	SIZE	SCALE	SOECIED TOLERANCES	MADE IN	SHEET			
1	storage rack	9	single round sink	DIRECTOR	GAD	2025/05/09	A3	1:1	±5		5 OF 5	WIDTH	2200 [MM]	
2	electric fryer, 2 tanks 2 baskets	10	single square sink	DESIGNER	BIGGUO	2025/05/09						LENGTH	5100 [MM]	
3	stainless steel range hood shell	11	Tracking light	REVIEWER	GAD	2025/05/09						HEIGHT	2490 [MM]	
4	electric griddle	12		#1, #2 5.1x2.2m Airstream			FOOD TRUCK CUSTOM SIDE ELEVATION		xEXTERIOR DIMENSIONS					
5	working bench fridge/freezer adjustable	13									xTITLE:		xDWG. NO.	
6	salad/pizza bench fridge	14												
7	Roof mounted AC unit	15												
8	Bench 1/2 fridge + 1/2 freezer	16												

